

INN650DA02A

650V GaN Enhancement-mode Power Transistor

Features

- Enhancement mode transistor-Normally off power switch
- Ultra high switching frequency
- No reverse-recovery charge
- Low gate charge, low output charge
- Qualified for industrial applications according to JEDEC Standards
- ESD safeguard

Benefits

- High efficiency power switching
- High power density
- Enables higher switching frequency
- System cost savings

Applications

- AC-DC converters
- DC-DC converters
- Totem pole PFC
- Fast battery charging
- High density power conversion
- High efficiency power conversion

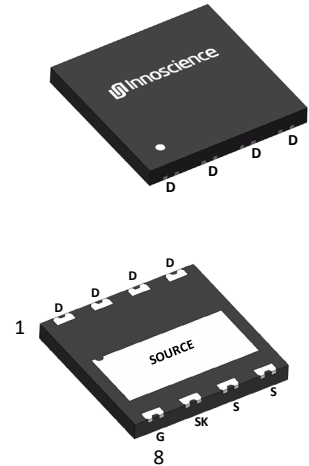

Gate	8
Drain	1,2,3,4
Kelvin Source	7
Source	5,6

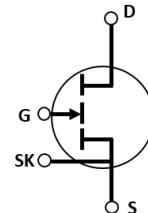

Table 1 Key Performance Parameters at $T_j = 25\text{ }^\circ\text{C}$

Parameter	Value	Unit
$V_{DS,max}$	650	V
$R_{DS(on),max}$	200	$m\Omega$
$Q_{G,typ}$	2	nC
$I_{DS,Pulse}$	22	A
$Q_{OSS @ 400V}$	19	nC
Q_{rr}	0	nC

Table 2 Ordering Information

Type/Ordering Code	Package	Marking
INN650DA02A	DFN 5X6	INN650DA02A

Table of contents

Features.....	1
Benefits	1
Applications	1
Table of contents	2
1 Maximum ratings	3
2 Thermal characteristics	4
3 Electrical characteristics	5
4 Electrical characteristics diagrams	7
5 Package outlines	13
6 Reel information	14
7 Revision history	15

1 Maximum ratings

at $T_j = 25\text{ }^\circ\text{C}$ unless otherwise specified.

Continuous application of maximum ratings can deteriorate transistor lifetime. For further information, contact Innoscience sales office.

Table 3 Maximum ratings

Parameter	Symbol	Values			Unit	Note/Test Condition
		Min.	Typ.	Max.		
Drain source voltage	$V_{DS,max}$	-	-	650	V	$V_{GS} = 0\text{ V}$, $I_D = 20\text{ }\mu\text{A}$
Drain source voltage transient ¹	$V_{DS(transient)}$	-	-	750	V	$V_{GS} = 0\text{ V}$, $V_{DS} = 750\text{ V}$
Continuous current, drain source	I_D	-	-	12	A	$T_c = 25\text{ }^\circ\text{C}$
Pulsed current, drain source ²	$I_{D,pulse}$	-	-	22	A	$T_c = 25\text{ }^\circ\text{C}$; $V_G = 6\text{ V}$; See Figure 16;
Pulsed current, drain source ²	$I_{D,Pulse}$	-	-	15	A	$T_c = 125\text{ }^\circ\text{C}$; $V_G = 6\text{ V}$; See Figure 17;
Gate source voltage, continuous ³	V_{GS}	-1.4	-	+7	V	$T_j = -55\text{ }^\circ\text{C}$ to $150\text{ }^\circ\text{C}$
Gate source voltage, pulsed	$V_{GS,pulse}$	-20	-	+10	V	$T_j = -55\text{ }^\circ\text{C}$ to $150\text{ }^\circ\text{C}$; $t_{Pulse} = 50\text{ ns}$, $f = 100\text{ kHz}$ open drain
Power dissipation	P_{tot}	-	-	75	W	$T_c = 25\text{ }^\circ\text{C}$
Operating temperature	T_j	-55	-	+150	$^\circ\text{C}$	
Storage temperature	T_{stg}	-55	-	+150	$^\circ\text{C}$	

¹ $V_{DS(transient)}$ is intended for surge rating during non-repetitive events, $t_{Pulse} < 1\text{ }\mu\text{s}$

² Pulse = 300 μs

³ The minimum V_{GS} is clamped by ESD protection circuit, as shown in Figure 10

2 Thermal characteristics

Table 4 Thermal characteristics

Parameter	Symbol	Values			Unit	Note/Test Condition
		Min.	Typ.	Max.		
Thermal resistance, junction-case	R_{thJC}	-	-	1.65	°C/W	
Reflow soldering temperature	T_{sold}	-	-	260	°C	MSL3

3 Electrical characteristics

at $T_j = 25\text{ }^\circ\text{C}$, unless specified otherwise

Table 5 Static characteristics

Parameter	Symbol	Values			Unit	Note/Test Condition
		Min.	Typ.	Max.		
Gate threshold voltage	$V_{GS(TH)}$	1.2	1.6	2.2	V	$I_D = 11\text{ mA}; V_{DS} = V_{GS}; T_j = 25\text{ }^\circ\text{C}$
		-	1.9	-		$I_D = 11\text{ mA}; V_{DS} = V_{GS}; T_j = 125\text{ }^\circ\text{C}$
Drain-source leakage current	I_{DSS}	-	2	20	μA	$V_{DS} = 650\text{ V}; V_{GS} = 0\text{ V}; T_j = 25\text{ }^\circ\text{C}$
		-	10	120		$V_{DS} = 650\text{ V}; V_{GS} = 0\text{ V}; T_j = 150\text{ }^\circ\text{C}$
Gate-source leakage current	I_{GSS}	-	40	-	μA	$V_{GS} = 6\text{ V}; V_{DS} = 0\text{ V}$
Drain-source on-state resistance	$R_{DS(on)}$	-	165	200	m Ω	$V_{GS} = 6\text{ V}; I_D = 3\text{ A}; T_j = 25\text{ }^\circ\text{C}$
		-	322	-		$V_{GS} = 6\text{ V}; I_D = 3\text{ A}; T_j = 150\text{ }^\circ\text{C}$
Gate resistance	R_G	-	2	-	Ω	$F = 5\text{ MHz}; \text{open drain}$

Table 6 Dynamic characteristics

Parameter	Symbol	Values			Unit	Note/Test Condition
		Min.	Typ.	Max.		
Input capacitance	C_{iss}	-	73	-	pF	$V_{GS} = 0\text{ V}; V_{DS} = 400\text{ V}; f = 100\text{ kHz}$
Output capacitance	C_{oss}	-	20	-	pF	$V_{GS} = 0\text{ V}; V_{DS} = 400\text{ V}; f = 100\text{ kHz}$
Reverse transfer capacitance	C_{riss}	-	0.2	-	pF	$V_{GS} = 0\text{ V}; V_{DS} = 400\text{ V}; f = 100\text{ kHz}$
Effective output capacitance, energy related ¹	$C_{o(er)}$	-	27	-	pF	$V_{GS} = 0\text{ V}; V_{DS} = 0\text{ to }400\text{ V}$
Effective output capacitance, time related ²	$C_{o(tr)}$	-	43	-	pF	$V_{GS} = 0\text{ V}; V_{DS} = 0\text{ to }400\text{ V}$
Output Charge	Q_{oss}	-	19	-	nC	$V_{GS} = 0\text{ V}; V_{DS} = 0\text{ to }400\text{ V}$

¹ $C_{o(er)}$ is the fixed capacitance that gives the same stored energy as C_{oss} while V_{DS} is rising from 0 to 400 V

² $C_{o(tr)}$ is the fixed capacitance that gives the same charging time as C_{oss} while V_{DS} is rising from 0 to 400 V

Table 7 Gate charge characteristics

Parameter	Symbol	Values			Unit	Note/Test Condition
		Min.	Typ.	Max.		
Gate charge	Q_G	-	2	-	nC	$V_{GS} = 0$ to 6 V; $V_{DS} = 400$ V; $I_D = 3$ A
Gate-source charge	Q_{GS}	-	0.18	-	nC	
Gate-drain charge	Q_{GD}	-	0.62	-	nC	
Gate Plateau Voltage	V_{Plat}	-	2.3	-	V	$V_{DS} = 400$ V; $I_D = 3$ A

Table 8 Reverse conduction characteristics

Parameter	Symbol	Values			Unit	Note/Test Condition
		Min.	Typ.	Max.		
Source-Drain reverse voltage	V_{SD}	-	2.7	-	V	$V_{GS} = 0$ V; $I_{SD} = 3$ A
Pulsed current, reverse	$I_{S,pulse}$	-	-	22	A	$V_G = -4$ V
Reverse recovery charge	Q_{rr}	-	0	-	nC	$I_{SD} = 3$ A; $V_{DS} = 400$ V
Reverse recovery time	t_{rr}	-	0	-	ns	
Peak reverse recovery current	I_{rrm}	-	0	-	A	

4 Electrical characteristics diagrams

at $T_j = 25\text{ }^\circ\text{C}$, unless specified otherwise

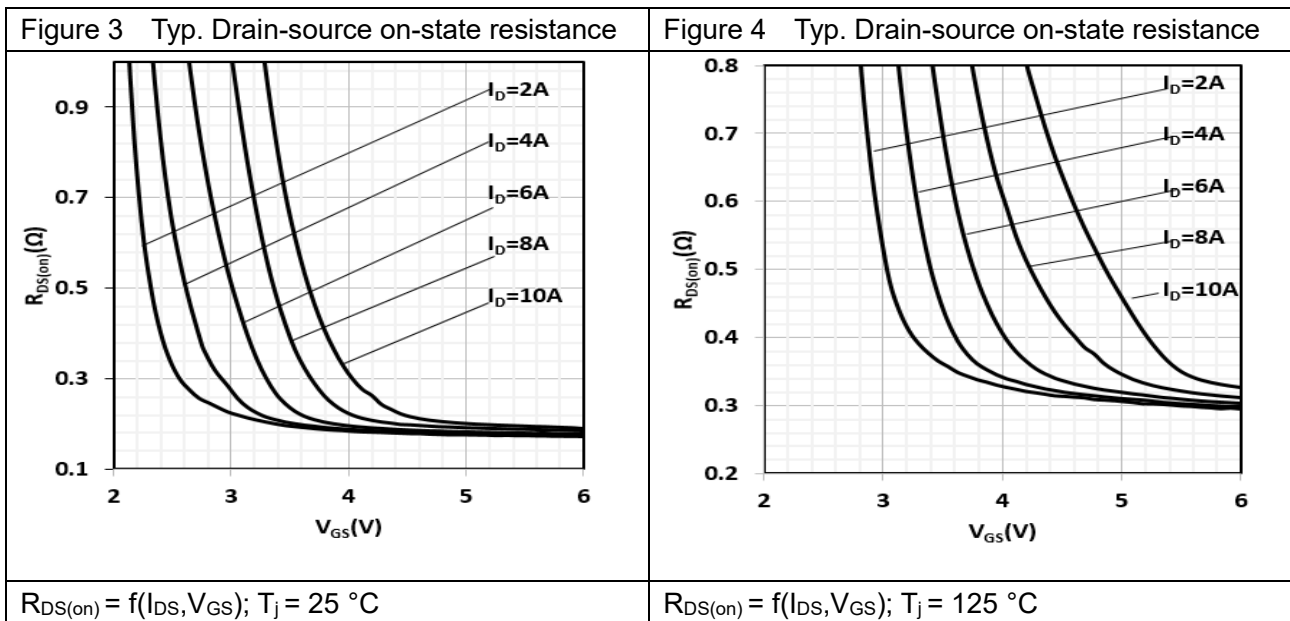
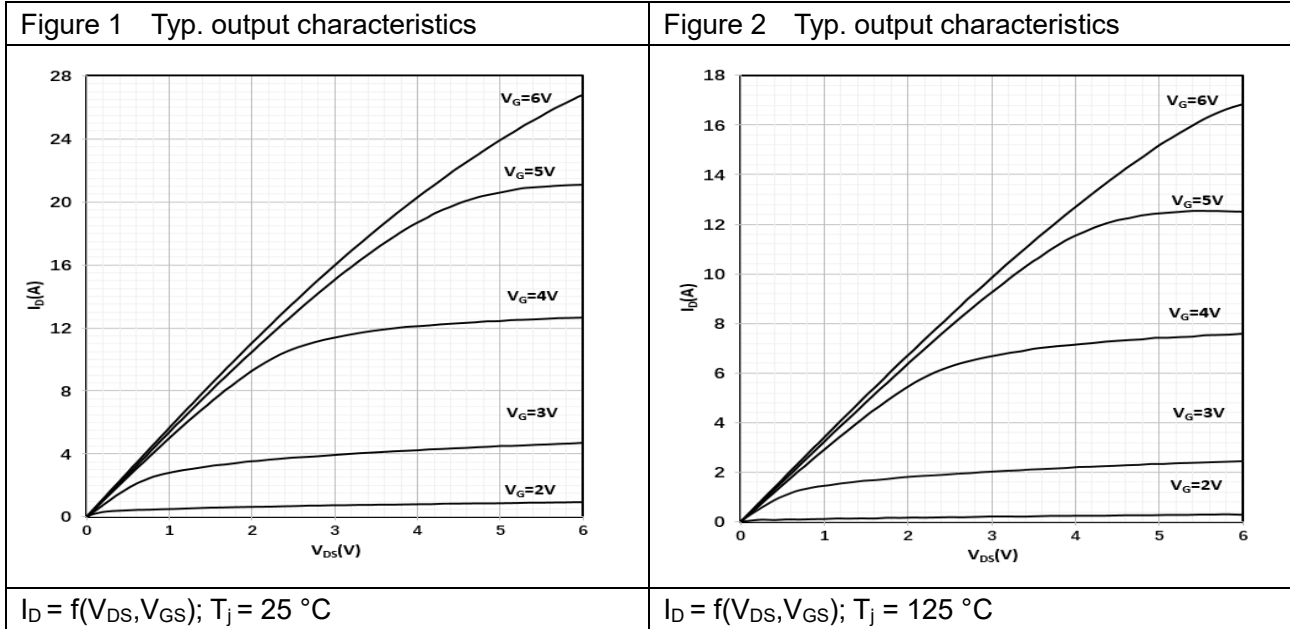
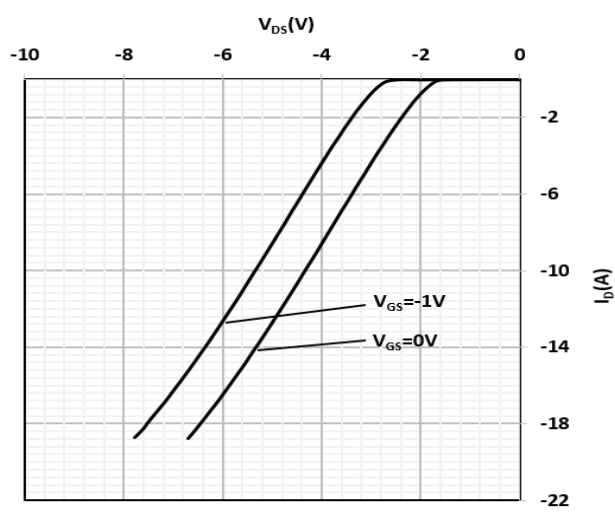
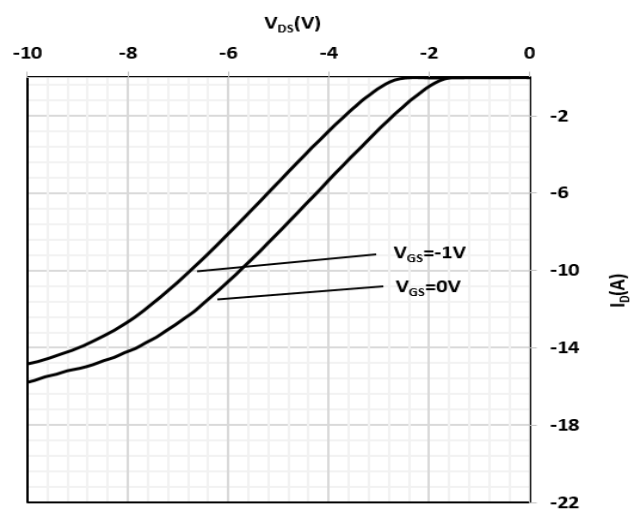

Figure 5 Typ. channel reverse characteristics



$I_D = f(V_{DS}, V_{GS}); T_j = 25\text{ °C}$

Figure 6 Typ. channel reverse characteristics



$I_D = f(V_{DS}, V_{GS}); T_j = 125\text{ °C}$

Figure 7 Typ. channel reverse characteristics

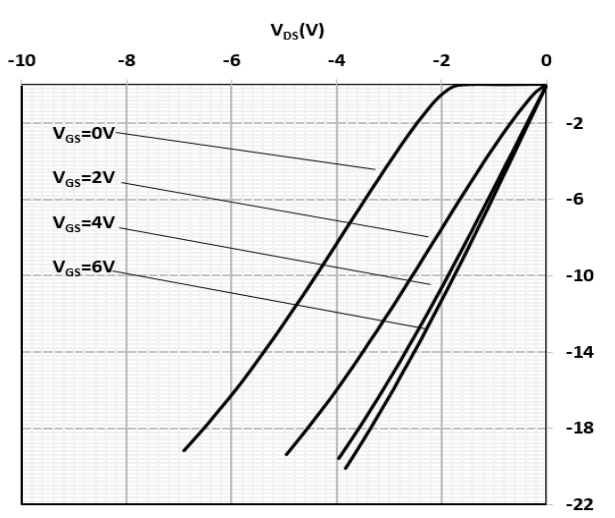

$I_D = f(V_{DS}, V_{GS}); T_j = 25\text{ °C}$

Figure 8 Typ. channel reverse characteristics

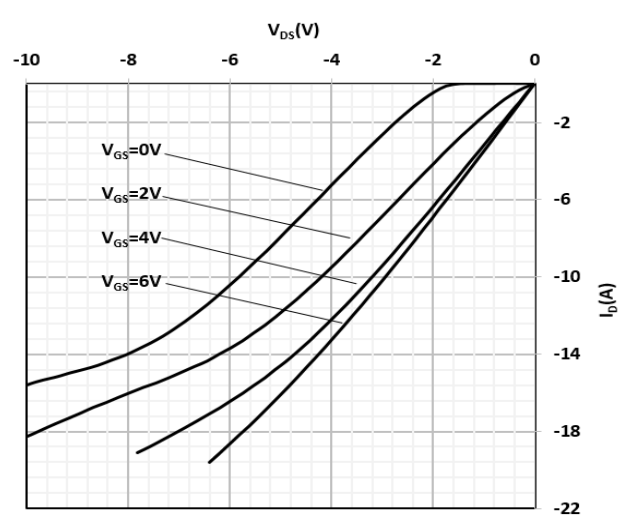

$I_D = f(V_{DS}, V_{GS}); T_j = 125\text{ °C}$

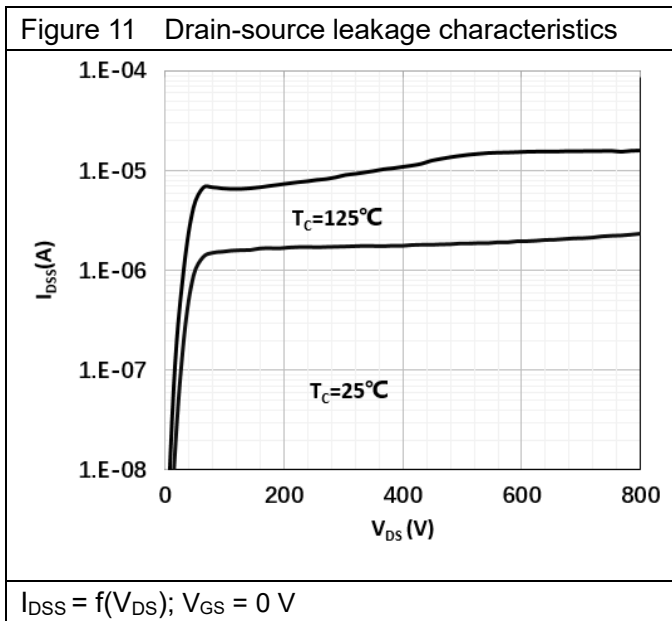
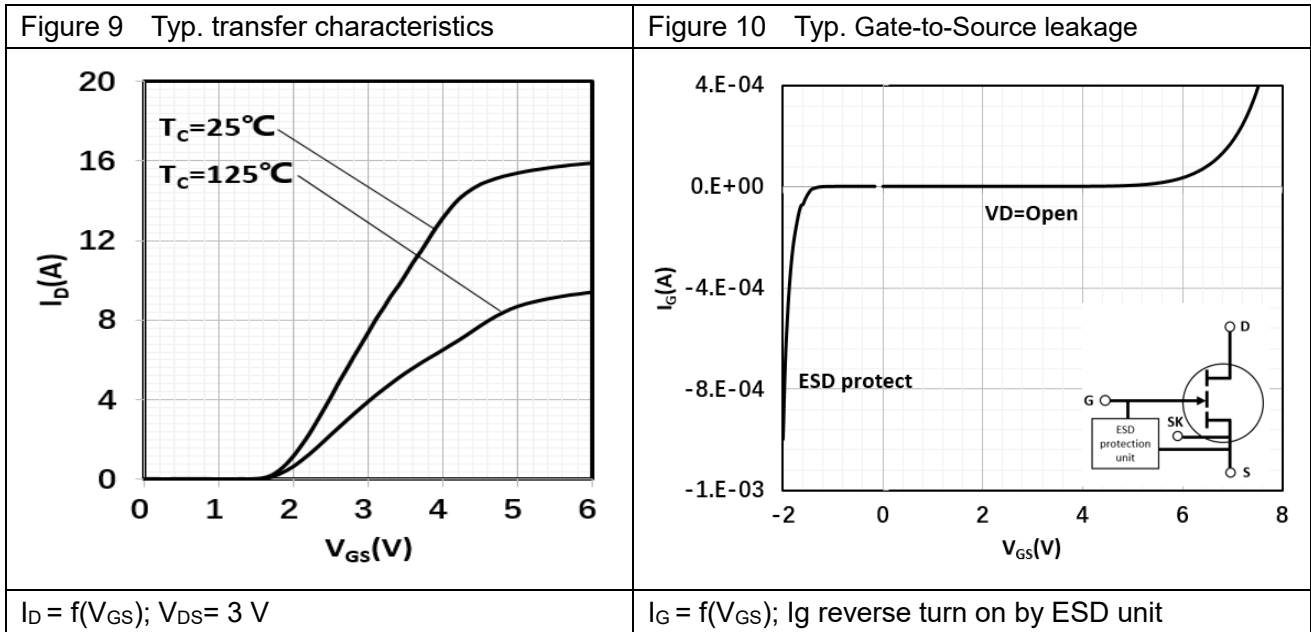

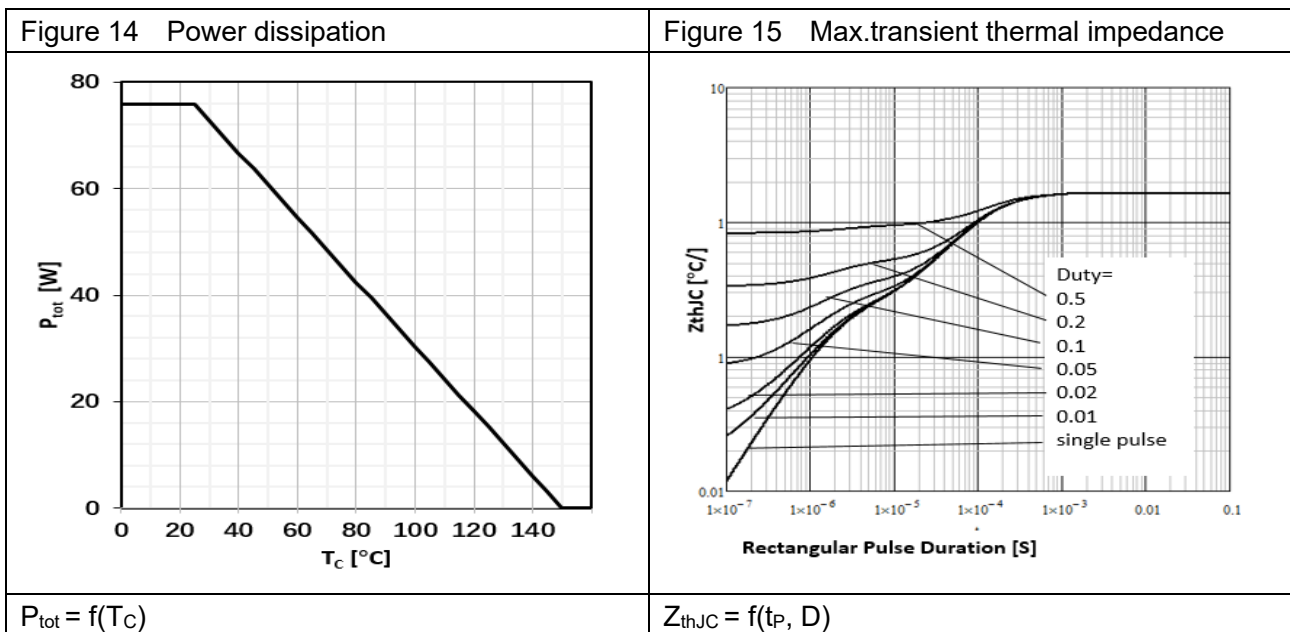
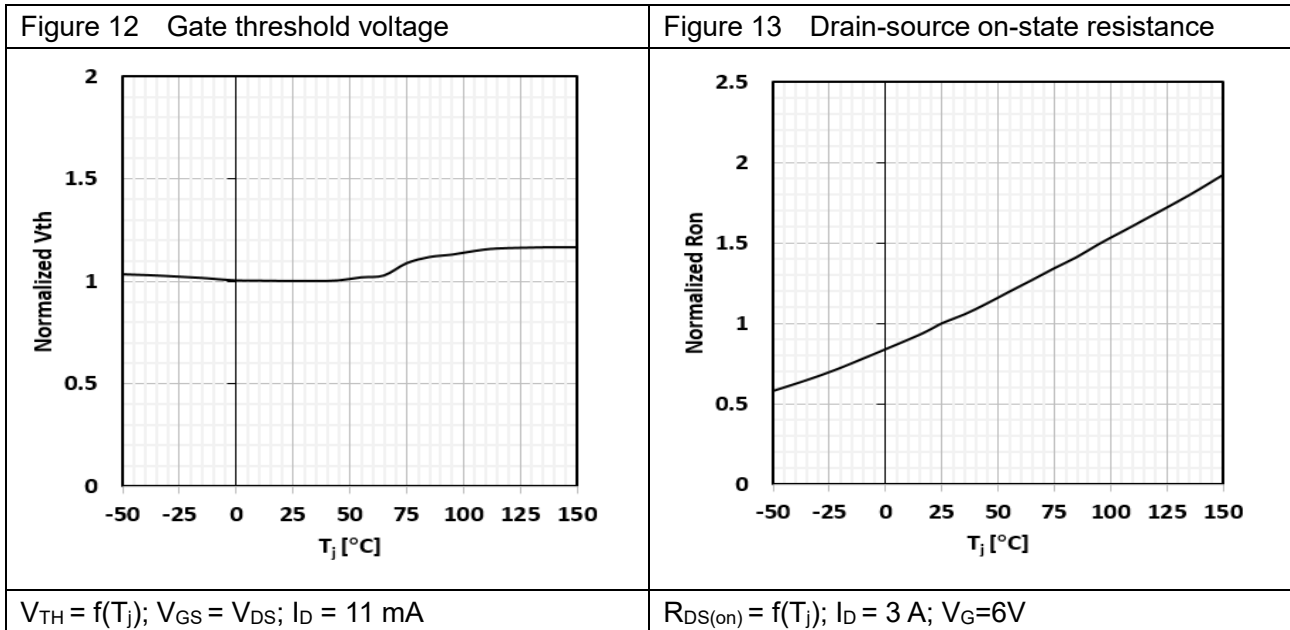

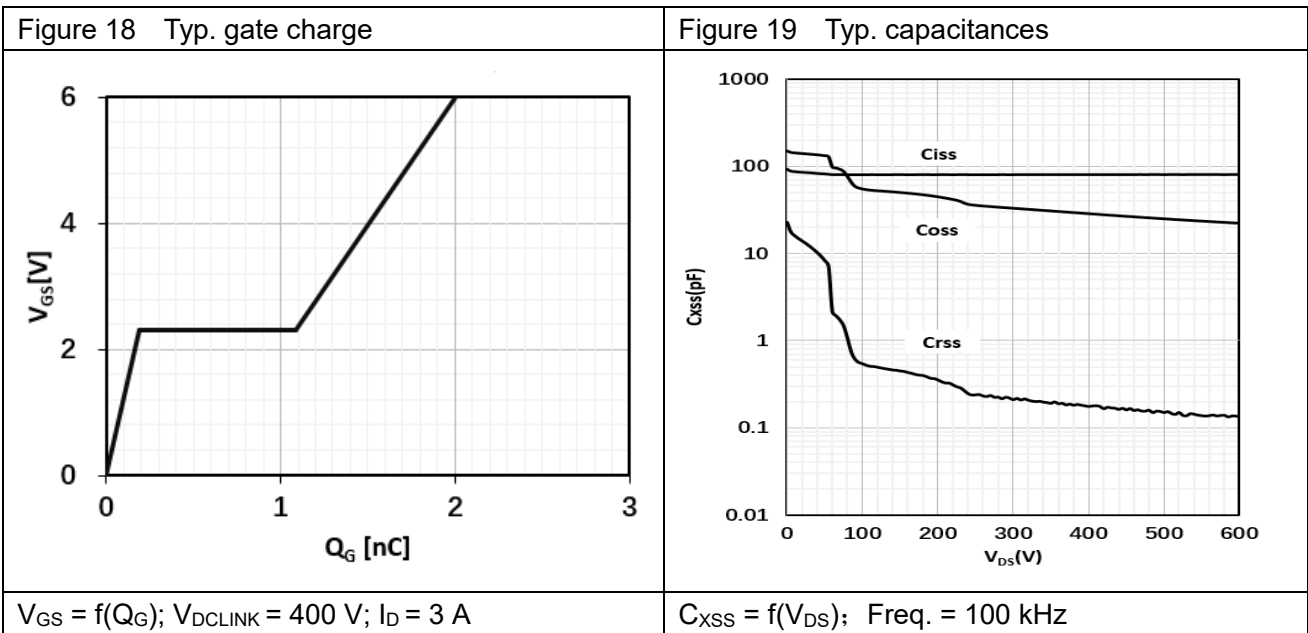
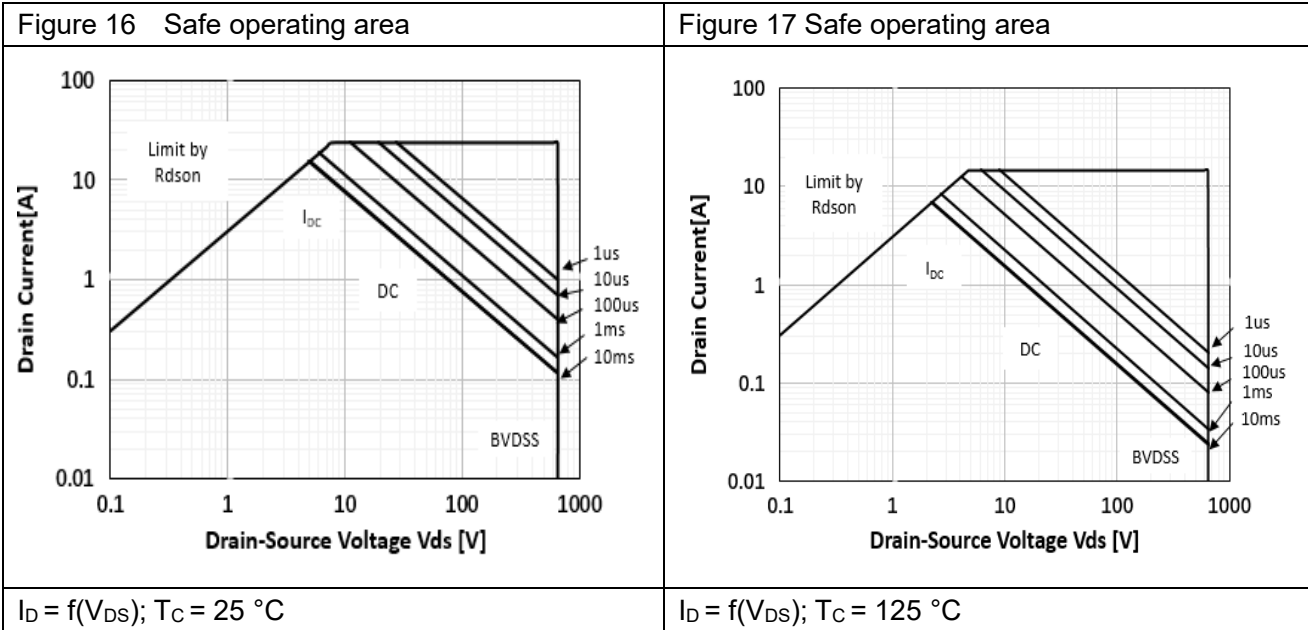

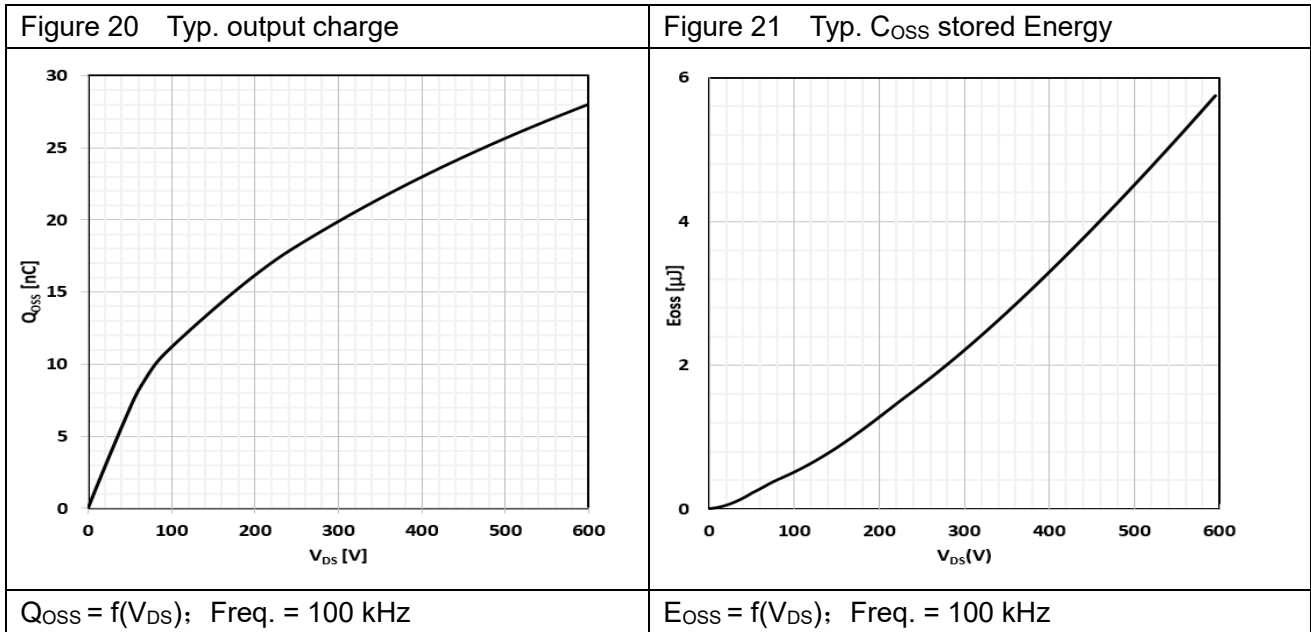

5 Package outlines

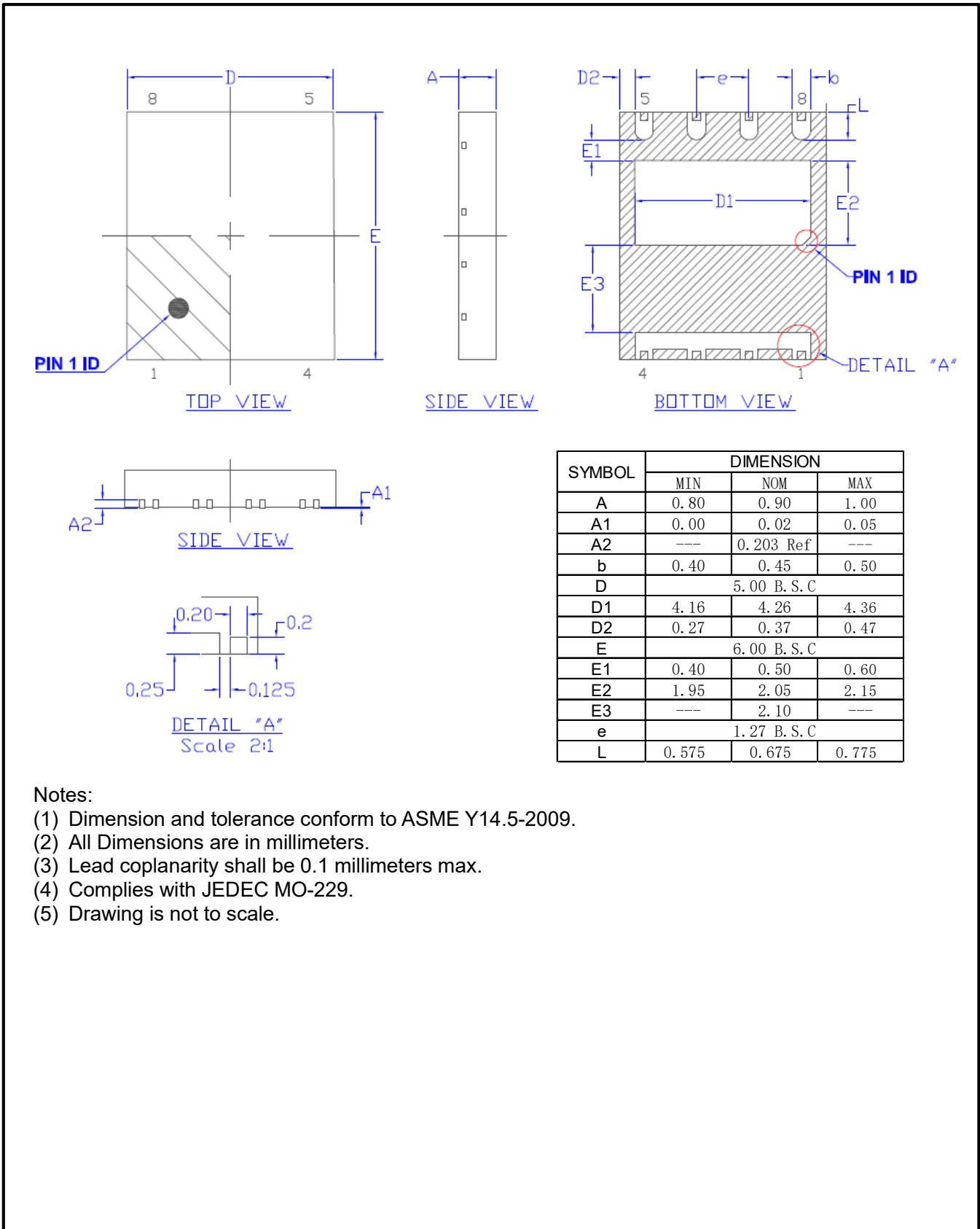

Notes:

- (1) Dimension and tolerance conform to ASME Y14.5-2009.
- (2) All Dimensions are in millimeters.
- (3) Lead coplanarity shall be 0.1 millimeters max.
- (4) Complies with JEDEC MO-229.
- (5) Drawing is not to scale.

7 Revision history

Major changes since the last revision

Revision	Date	Description of changes
1.0	2021-1-28	Preliminary version release